

**ebm-papst St. Georgen GmbH & Co. KG**

Hermann-Papst-Str. 1
 D-78112 St. Georgen
 Phone +49 (0) 7724 81-0
 Fax +49 (0) 7724 81-1309
 info2@de.ebmpapst.com
 www.ebmpapst.com

Nominal data

Type	8312 NH	
Nominal voltage	V	12
Nominal voltage range	V	6 .. 15
Speed (rpm)	min ⁻¹	5300
Power consumption	W	4.0
Min. ambient temperature	°C	-20
Max. ambient temperature	°C	75
Air flow	m ³ /h	80
Sound power level	B	5.5
Sound pressure level	dB(A)	42

ml = Max. load · me = Max. efficiency · fa = Free air · cs = Customer specification · ce = Customer equipment
 Subject to change

Technical description

Weight	0.16 kg
Dimensions	80 x 80 x 32 mm
Impeller material	Glass-fiber reinforced PA plastic
Housing material	Glass-fiber reinforced PBT plastic
Part no.	9292910115
Airflow direction	Exhaust over struts
Direction of rotation	Counterclockwise, viewed toward rotor
Bearing	Ball bearing
Service life L10 at 40 °C	82500 h
Service life L10 at maximum temperature	32500 h
Cable	With leads AWG 26, TR 64

Product drawing

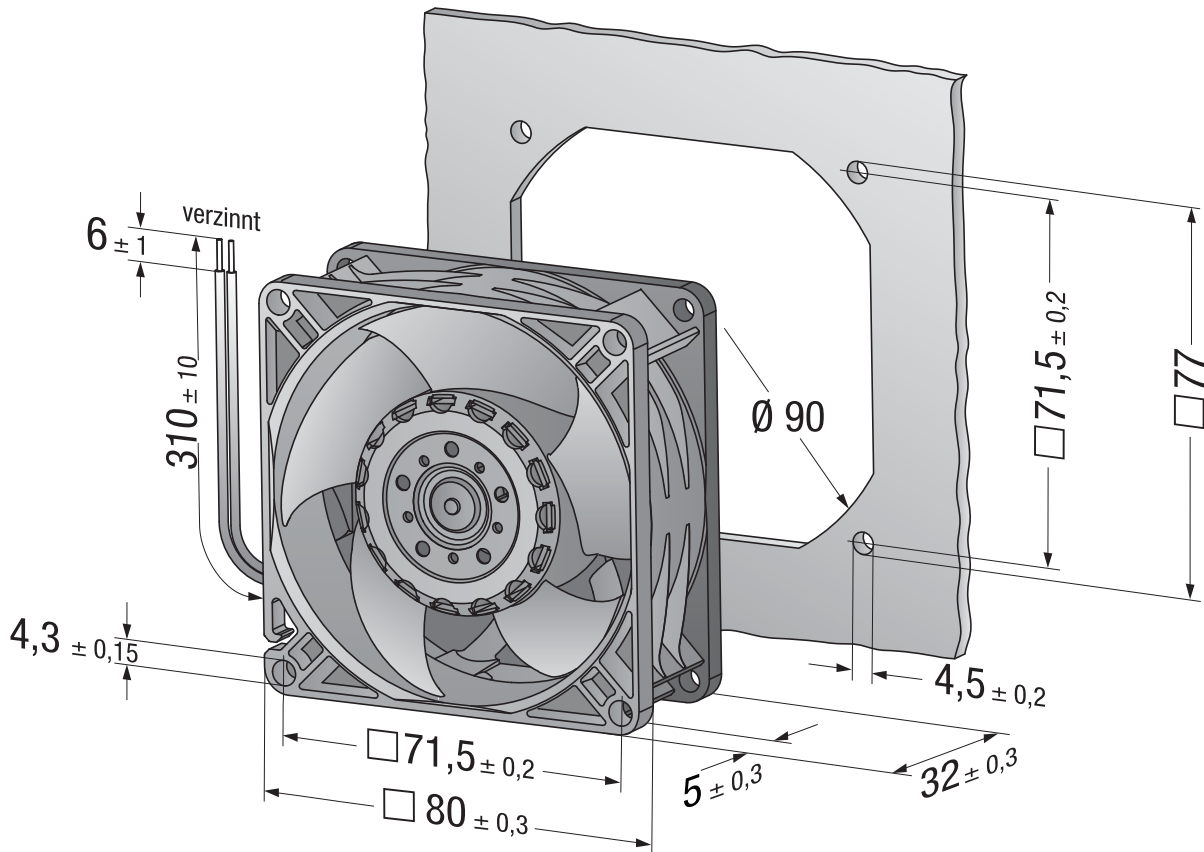

Curves

